



TD-YXH0302

Junction Box

Features

- Aluminum alloy material with surface spray treatment
- Camera cables can be perfectly collected to the junction box so that the installation looks more elegant
- Bottom inlet and side inlet
- Available for wall or ceiling mounting
- Water-proof design

Specifications

Model	HD-YXH0302
Material	Aluminum alloy
Color	White
Protection Grade	IP66
Min. Packaging Quantity	20
Packing Size	375x330x310mm
Dimension	139.3x50mm
Load Bearing	The wall must be strong enough to withstand at least 3 times the weight of the camera and the junction box
Net Weight	512g
Working Temperature	-40°C~+60°C(-40°F~+140°F)
Working Humidity	10%~90%

Available Model

Available Model	HD-YXH0302	Junction Box
-----------------	------------	--------------

Dimensions

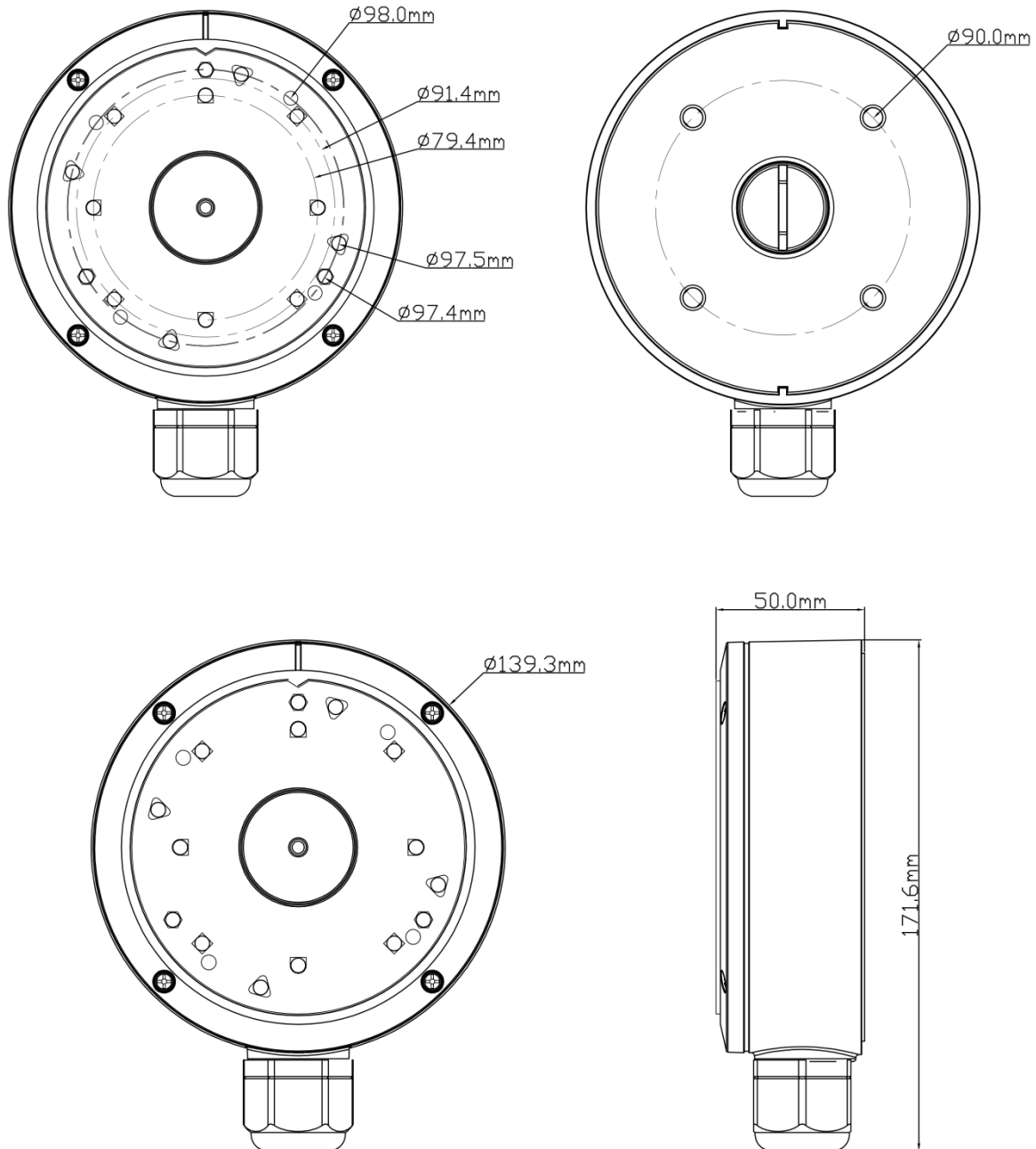

Shenzhen TVT Digital Technology Co., LTD.

Address: 23rd Floor, Block B4, Building NO.9, Shenzhen Bay Eco-Technology Park, Nanshan District, Shenzhen, Guangdong Province, P.R. China

Tel: +86-755-36995888

Website: <http://en.tvt.net.cn>

Fax: +86-755-33104777

E-mail: overseas@tvt.net.cn