



NP2-12

Sealed Rechargeable
Lead-Acid Battery

12V, 2Ah

Specifications

- **NOMINAL VOLTAGE:** 12V
- **NOMINAL CAPACITY:**
 - 20 hr. rate of .100A to 10.50V 2.0Ah
 - 10 hr. rate of .186A to 10.50V 1.86Ah
 - 5 hr. rate of .340A to 10.20V 1.7Ah
 - 1 hr. rate of 1.20A to 9.60V 1.2Ah
- **WEIGHT (approx.):** 1.54 pounds (0.70 kgs.)
- **ENERGY DENSITY (20 hr. rate):** 1.56 WH/cubic inch (95 WH/liter)
- **SPECIFIC ENERGY (20 hr. rate):** 15.6 WH/pound (34 WH/kg)
- **INTERNAL RESISTANCE OF CHARGED BATTERY:** 80 milliohms (approx.)
- **MAXIMUM DISCHARGE CURRENT WITH STANDARD TERMINALS:** 40 amperes
- **MAXIMUM SHORT-DURATION DISCHARGE CURRENT:** 80 amperes
- **OPERATING TEMPERATURE RANGE:**
 - CHARGE 5°F to 122°F (-15°C to 50°C)
 - DISCHARGE -4°F to 140°F (-20°C to 60°C)
- **CHARGE RETENTION (shelf life) at 68°F (20°C):**
 - 1 month 97%
 - 3 months 91%
 - 6 months 85%
- **LIFE EXPECTANCY:**
 - STANDBY USE 3 to 5 years
 - CYCLE USE (approx.):
 - 100% depth of discharge 250 cycles
 - 50% depth of discharge 550 cycles
 - 30% depth of discharge 1200 cycles
- **SEALED CONSTRUCTION:** Can be operated in any position without leakage.
- **STANDARD TERMINAL:** Quick Disconnect .187 and Flat Contact
- **HOUSING MATERIAL:** ABS Resin

Terminal

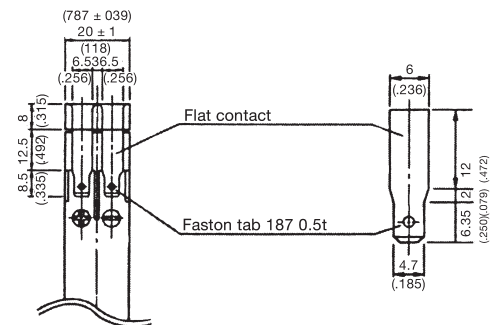

DIMENSIONS: (INCHES)

Dimensions

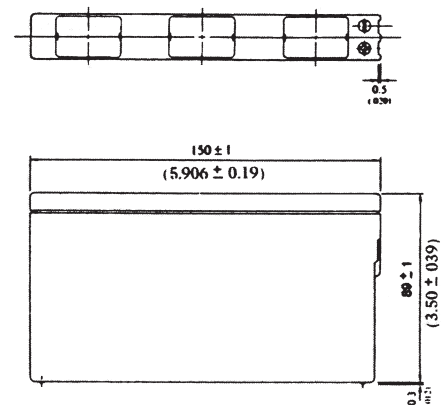

DIMENSIONS: MM (INCHES)

UL listing pending - File No MH16464

EnerSysTM

Power/Full Solutions



Publication No: EN-NP2-12-001 • June 2005

DISCHARGE CHARACTERISTIC CURVES AT 25°C (77°F)

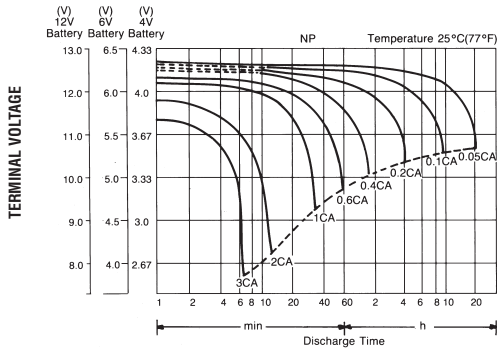

TEMPERATURE EFFECTS IN RELATION TO BATTERY CAPACITY

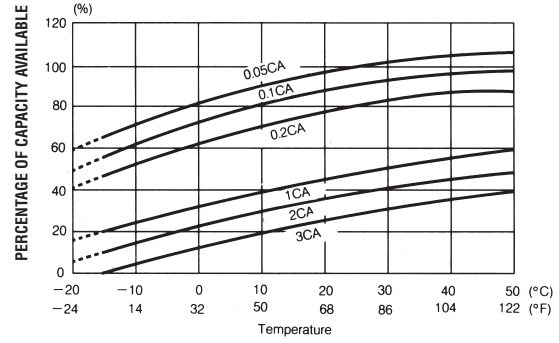

SELF DISCHARGE CHARACTERISTICS

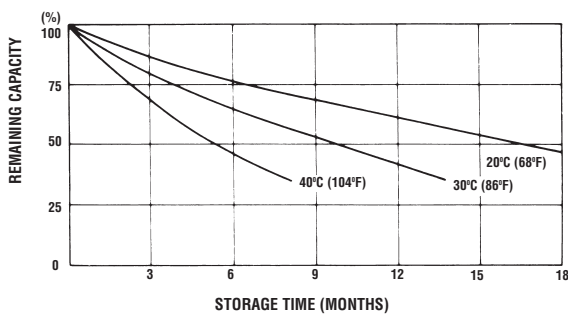

OPEN CIRCUIT VOLTAGE VS REMAINING CAPACITY

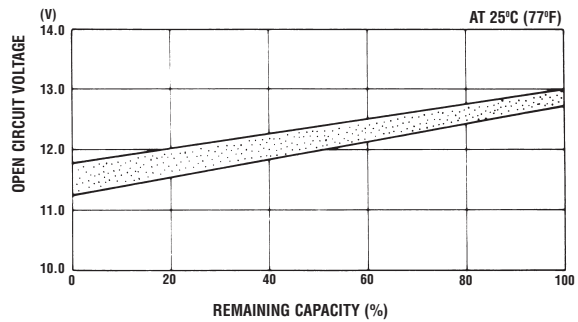

CYCLE SERVICE LIFE IN RELATION TO DEPTH OF DISCHARGE

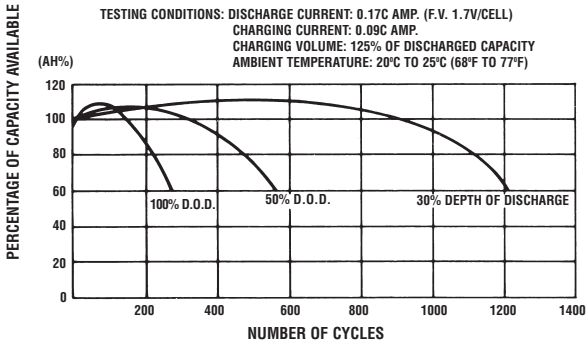

FLOAT SERVICE LIFE

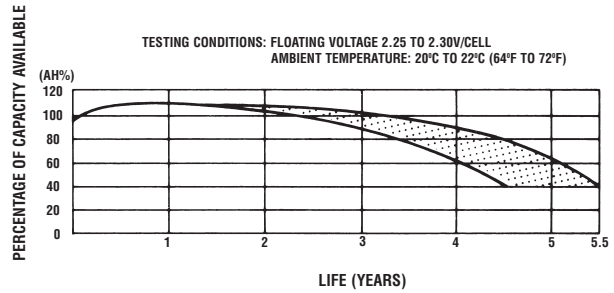

When the battery will be used by current in excess of 3C, consult with EnerSys prior to use.

CHARGING METHODS (At 20°C)

Cycle use: Maximum charging current 0.5A
Charging voltage 14.4 to 15.0V

CAUTION

- Avoid short circuit
- Do not charge in a sealed container.

Standby use: Float charging voltage 13.50 to 13.80V



EnerSys
P.O. Box 14145
Reading, PA 19612-4145
USA
Tel: +1-610-208-1991
+1-800-538-3627

EnerSys EMEA
Brussels, Belgium
Tel: +32 (0)2 247 94 47
EnerSys Asia
Guandong, China
Tel: +86 755 689 9220

Represented by:

© 2005 EnerSys. All rights reserved.
Trademarks are the property of EnerSys and its affiliates unless otherwise noted.