

H30 series

Harden-Graded Industrial Gigabit PoE Switches



H30-082-30



H30-044-30
H30-044-90



The H30 series of **Harden-Graded Industrial Unmanaged PoE Switches** are designed with IP30, 12KV PoE Ethernet port surge protection, and operation temperature between -40°C and 75°C during harsh weather conditions. Besides enabling connections of PoE af/at PDs, H30-044-90 is specially designed for latest PoE bt/Ultra PoE(>25.5W) PDs such as IR PTZ cameras, multi-sensor cameras, and long range PoE applications. The H30 series provide multi-port Gigabit PoE (10M/100M/1G) delivering data and power to PoE PDs over a single network cable as well as additional SFP transceiver slots for flexible uplink. The H30 series has three sub-models classified as easy-to-install power source equipment (PSE) and provide power up to 30W/60W/95W per port.

Features

- 60W x4 or 95W x2 + 30W x2 (H30-044-90 only)
- 30W IEEE802.3at compliant
- 12KV surge protection on each PoE port
- Operating temperature between -40°C and 75°C
- Flexible SFP transceiver ports for uplink
- Supporting 10/100/1000Mbps data rates
- DIN-Rail mounting and wall mounting
- IP30 rating
- IEEE 802.3az Energy Efficient Ethernet standard for green power

PoE bt/Ultra PoE IR PTZ Camera Applications

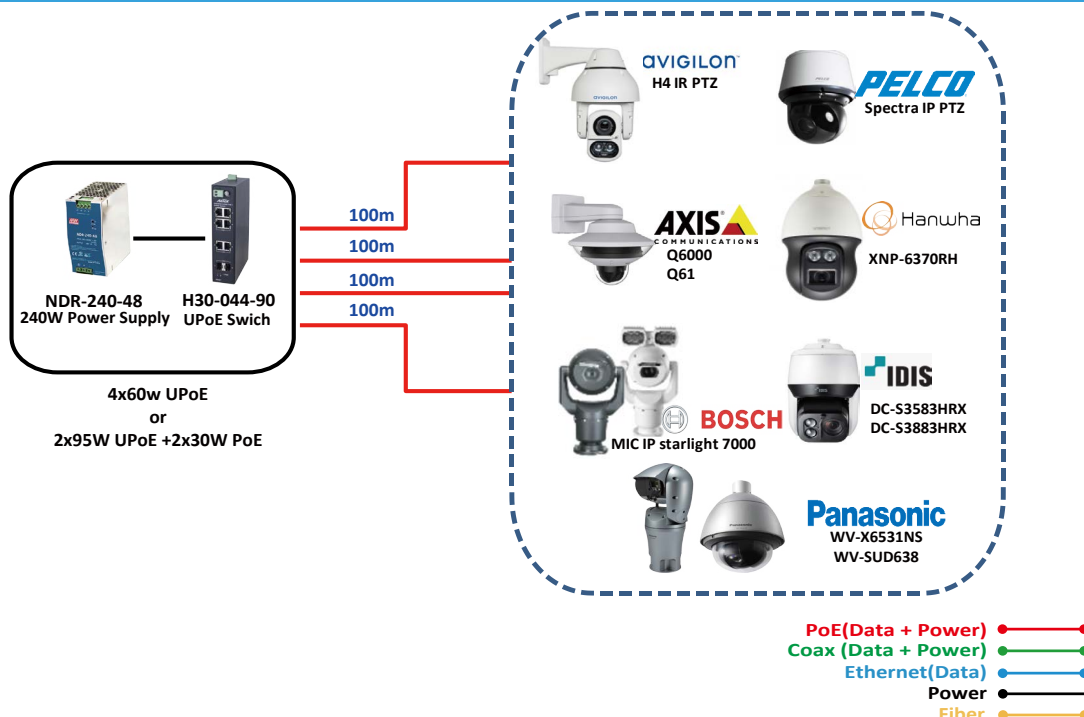

PoE bt/Ultra PoE IR PTZ Camera Applications

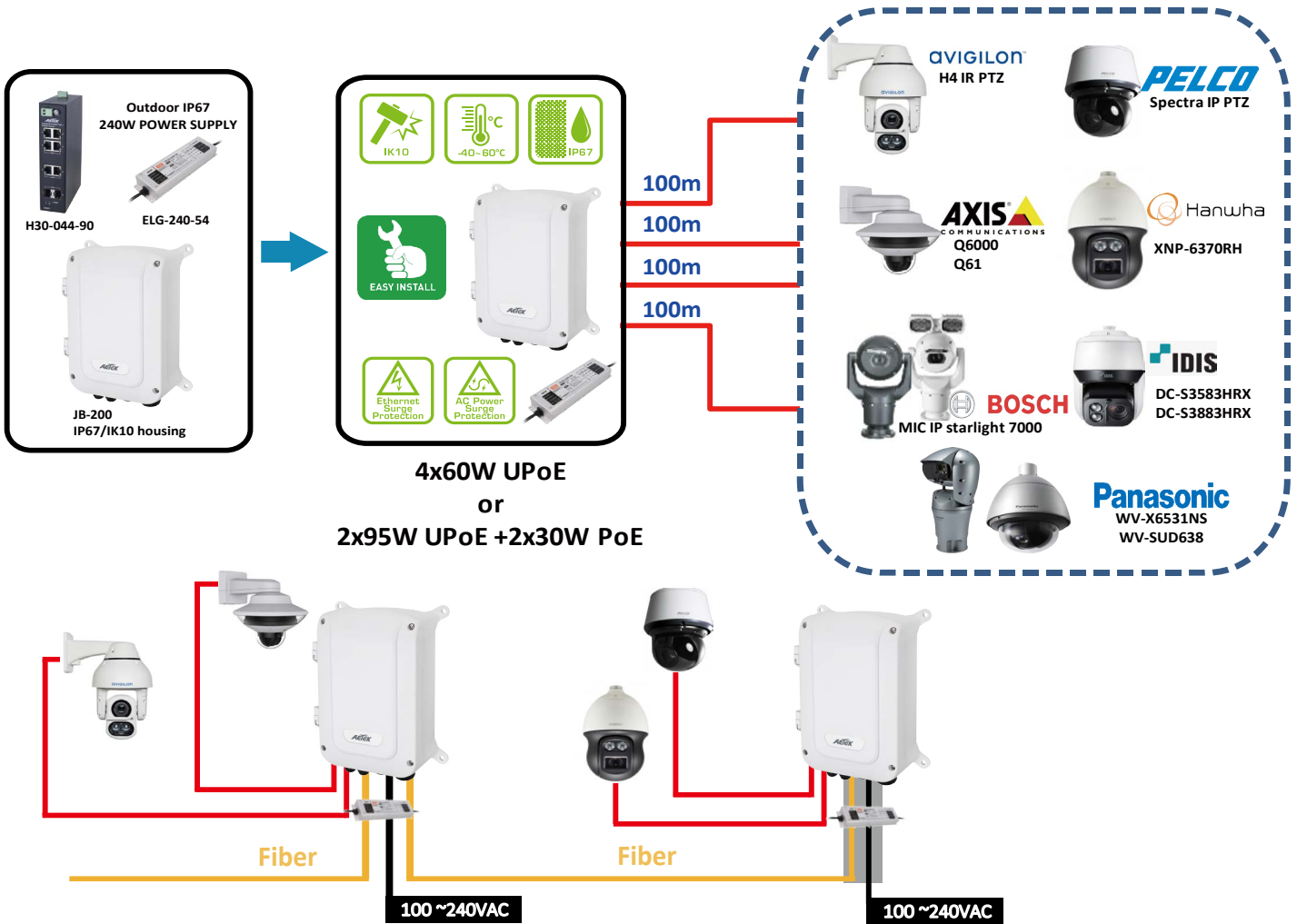

PoE Extender Applications

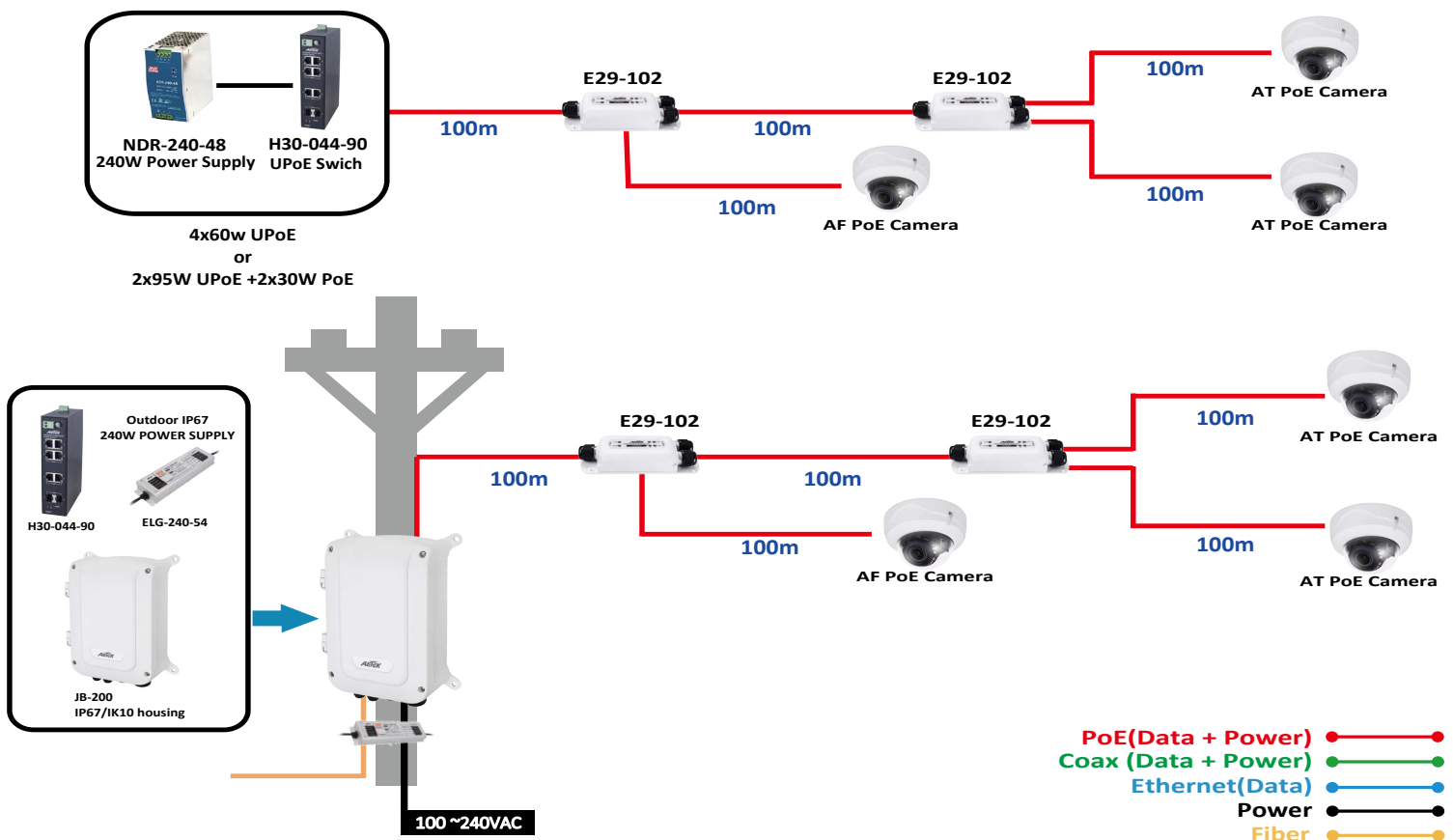

Mobotix M15/M16/M25/M26 with IR Applications

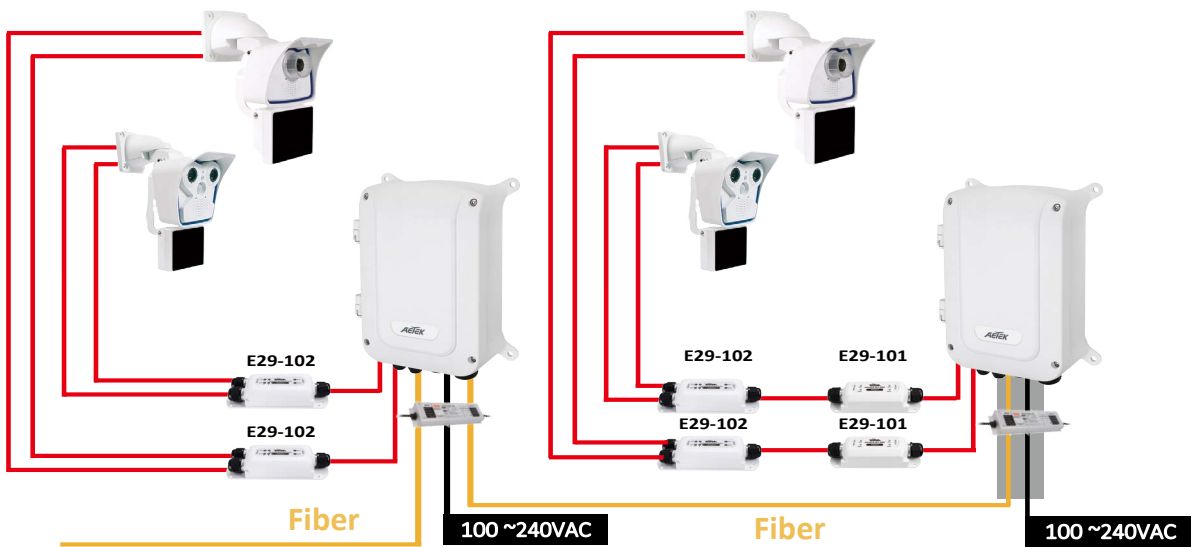
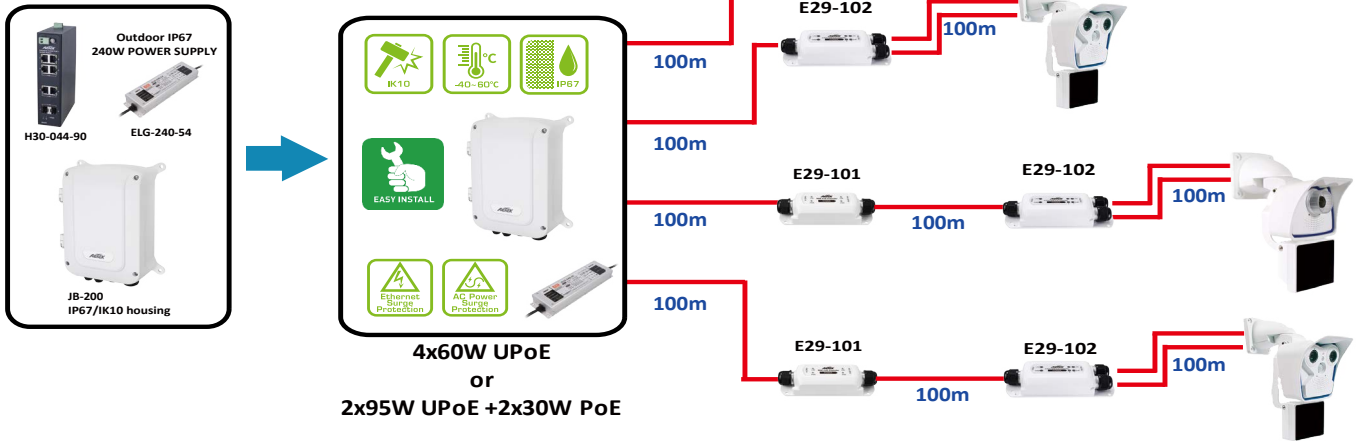
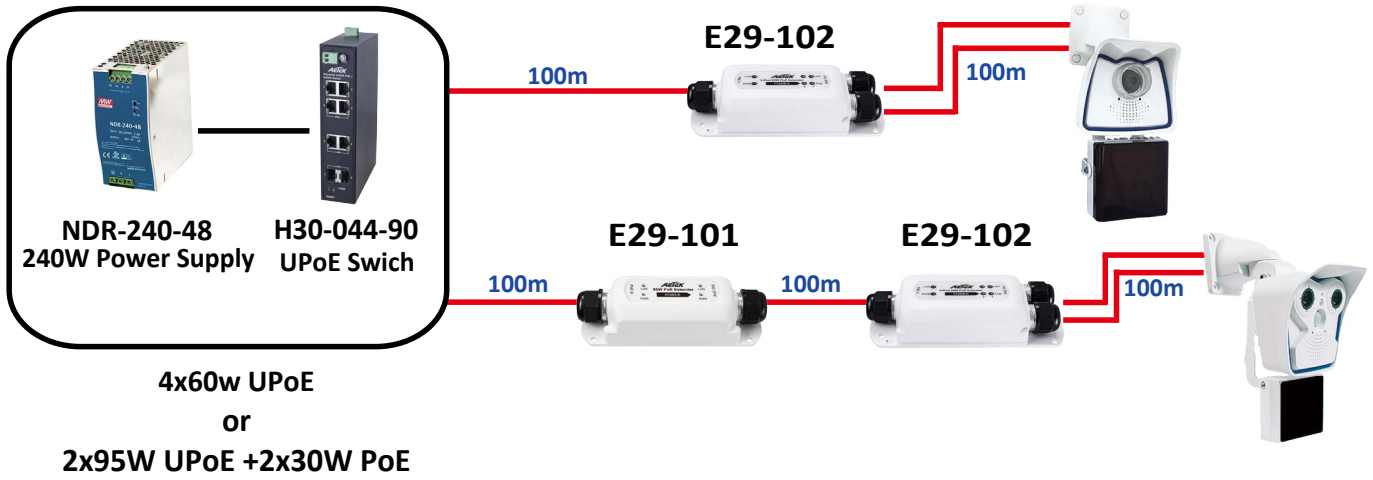

- PoE (Data + Power) ●
- Coax (Data + Power) ●
- Ethernet (Data) ●
- Power ●
- Fiber ●

Long Range EPoC Applications



4x60w UPoE

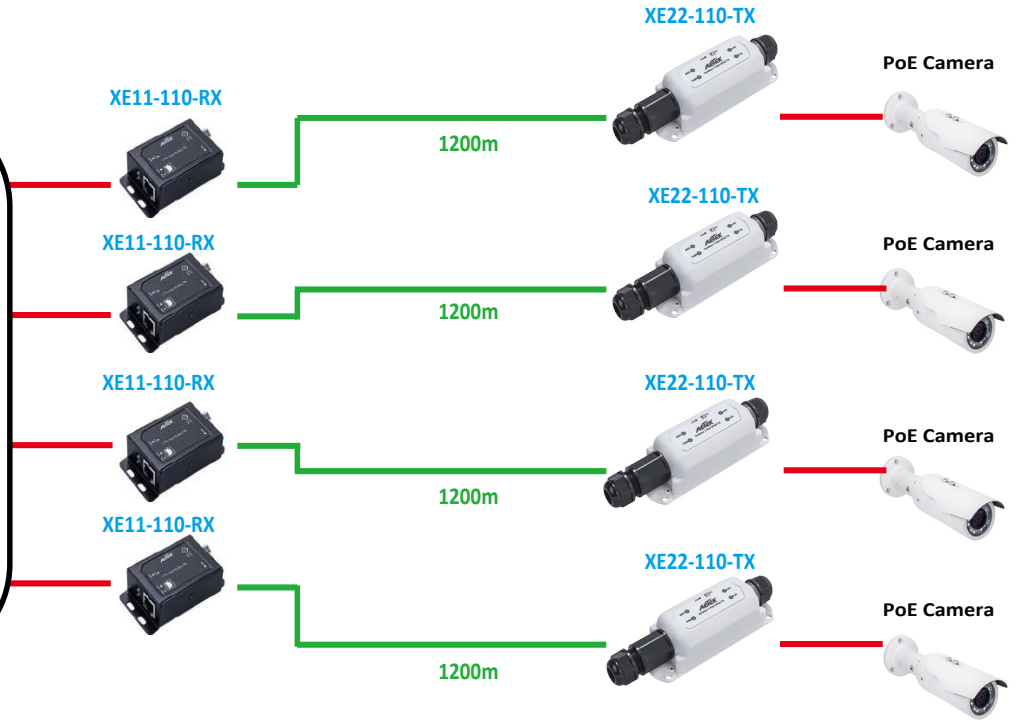

4x60w UPoE

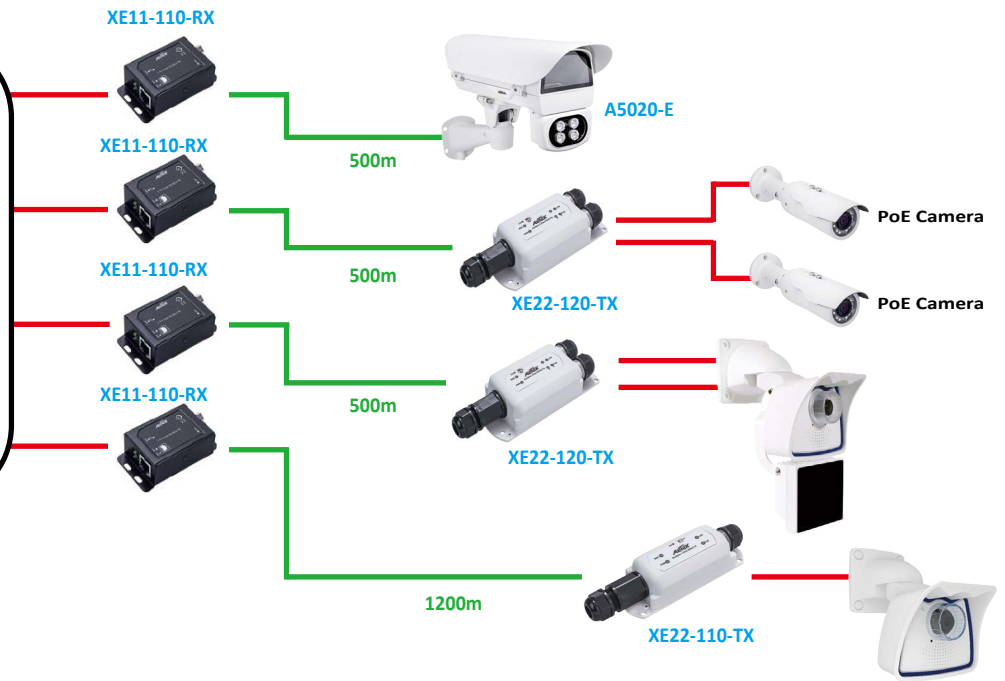

- PoE(Data + Power) —●—●—
- Coax (Data + Power) —●—●—
- Ethernet(Data) —●—●—
- Power —●—●—
- Fiber —●—●—

Specifications

	H30-044-30	H30-082-30	H30-044-90
Networking Specifications			
Total Gigabit Ports	8	10	8
Gigabit PoE Ports (10M/100M/1G)	4 x 30W PoE	8 x 30W PoE	4 x 60W UPoE or 2x 95W UPoE + 2x30W PoE
SFP Slots (1G)	2	2	2
Gigabit Ports (RJ45)	2	-	2
Forwarding Capacity	11.904Mpps	14.88Mbps	11.904Mpps
Mac Table	4k	4k	4k
Jumbo Frames	9,216 Bytes	9,216 Bytes	9,216 Bytes
Switching Capacity	16 Gbps	20 Gbps	16 Gbps
Power Specifications			
Power 1 : Input Voltage	48VDC ~ 56VDC	48VDC ~ 56VDC	54VDC ~ 56VDC
Power 2 : Input Voltage	48VDC ~ 56VDC	48VDC ~ 56VDC	54VDC ~ 56VDC
Output Voltage Range /per PoE Port	48~56 VDC PoE IEEE 802.3af (Max. 15.4W) output PoE+ IEEE802.3at (Max. 30W) output	48~56 VDC PoE IEEE 802.3af (Max. 15.4W) output PoE+ IEEE802.3at (Max. 30W) output	54~56 VDC PoE IEEE 802.3af (Max. 15.4W) output PoE+ IEEE802.3at (Max. 30W) output UPoE (Max. 60W) output UPoE (Max. 95W) output
PoE Power Budget	120W	240W	240W
Surge Protection /each PoE Port	12KV	12KV	12KV
Mechanical Specifications			
Dimensions (WxHxD)	171.6 x 132 x 39 mm	171.6 x 132 x 39 mm	171.6 x 147 x 39 mm
Weight	0.8KG	0.8KG	0.9KG
Connectors	RJ45 x 6, SFP x 2, Terminal Black x2	RJ45 x 8, SFP x 2, Terminal Black x2	RJ45 x 8, SFP x 2, Terminal Black x2
Environmental Specifications			
Operating Temperature	-40°C~ 75°C (-40°F~ 167°F)	-40°C~ 75°C (-40°F~ 167°F)	-40°C~ 75°C (-40°F~ 167°F)
Storage Temperature	-40°C~ 85°C (-40°F~ 185°F)	-40°C~ 85°C (-40°F~ 185°F)	-40°C~ 85°C (-40°F~ 185°F)
Operating Humidity	5% ~ 95% non-condensing	5% ~ 95% non-condensing	5% ~ 95% non-condensing
Certifications			
EMC	CE, FCC, VCCI, C-Tick	CE, FCC, VCCI, C-Tick	CE, FCC, VCCI, C-Tick
Safety	EN60950-1, IEC60950-1	EN60950-1, IEC60950-1	EN60950-1, IEC60950-1
Surge	EN61000-4-5	EN61000-4-5	EN61000-4-5

Ordering Information

PoE Switches

	<p>H30-044-30</p> <ul style="list-style-type: none"> 4xGbE PoE (30W) + 2xGbE SFP + 2xGbE RJ45 		<p>H30-082-30</p> <ul style="list-style-type: none"> 8xGbE PoE (30W) + 2xGbE SFP 		<p>H30-044-90</p> <ul style="list-style-type: none"> 4xGbE UPoE + 2xGbE SFP + 2xGbE RJ45
---	---	---	--	---	--



Optional Accessories

SFP Modules

SFP Modules

			
<p>SFP-ISX-X5 Industrial Gigabit SFP Transceiver</p> <ul style="list-style-type: none"> MMF 0.5 km -40°C ~85°C 	<p>SFP-ISX-02 Industrial Gigabit SFP Transceiver</p> <ul style="list-style-type: none"> MMF 2 km -40°C ~85°C 	<p>SFP-ILX-10 Industrial Gigabit SFP Transceiver</p> <ul style="list-style-type: none"> SMF 10 km -40°C ~85°C 	<p>SFP-ILX-40 Industrial Gigabit SFP Transceiver</p> <ul style="list-style-type: none"> SMF 40 km -40°C ~85°C



Power Supplies

Din Rail Power Supply		Outdoor IP67 Power Supply
 <p>NDR-120-48</p> <ul style="list-style-type: none">• 100-240VAC input• 120W / 48-55VDC output	 <p>NDR-240-48</p> <ul style="list-style-type: none">• 100-240VAC input• 240W / 48-56VDC output	 <p>ELG-240-54</p> <ul style="list-style-type: none">• 100-240VAC input• 240W / 54VDC output

Outdoor Cabinet

Cabinet Housing
 <p>JB-200</p> <ul style="list-style-type: none">• IP67, IK10• M16x4 pcs, M25 x2pcs

Cabinet Brackets

Pole Mount Brackets		Corner Mount Bracket
 <p>AT-100 Pole Mount Adapter</p>	 <p>AT-101 Pole Mount Adapter</p>	 <p>AT-200 Corner Mount Adapter</p>